

MASTERPIUMA  LA PROFESSIONALE
The professional choice

MASTERPIUMA 3 LA COMPLETA

The full optional

Incisione ergonomica a spinta
Ergonomic Push incision

Massima precisione
Maximum precision

Lubrificazione integrata
Integrated lubrication point

Incisione assistita da 0 a 22 mm
Incision assistance from 0 to 22 mm

100% materiale riciclabile
100% recycled material

Telaio a scatola rinforzato
Reinforced frame

Piedoni antiscivolo
Non-slip feet

Piani in acciaio molleggiati
Sprung metal support tables

Braccio estensibile per grandi formati
Extension arm for supporting big tiles

Squadretta di riferimento ribaltabile
Measurement square flips out of way if not required



Ammortizzatore
Shock absorber (bumper)

Box per rotelle
Box for spare incision wheel

Rotazione squadra $-45^\circ \div +45^\circ$
Square rotation $-45^\circ \div +45^\circ$

Doppia scala graduata a "lente"
Dual millimeter scale - "lens effect"

Squadra goniometrica rinforzata
Reinforced Geometric square



MASTERPIUMA 3 LA VERSATILE

The multipurpose

- 1 Incisione ergonomica a spinta
Ergonomic Push incision
- 2 Ammortizzatore
Shock absorber (bumper)
- 3 Massima precisione
Maximum precision
- 4 Piedoni antidrucciolo
Non-slip feet
- 5 Cambio rapido della rotella di incisione
Quick & easy change cutting wheel
- 6 Doppio spacco "pulito"
Dual splitting device
- 7 Multifunzione: ideale per ceramica, vetro e mosaico
Multifunctional & ideal for ceramic, glass and mosaic
- 8 Rotella di incisione a vista titanium gold
High visibility of incision wheel

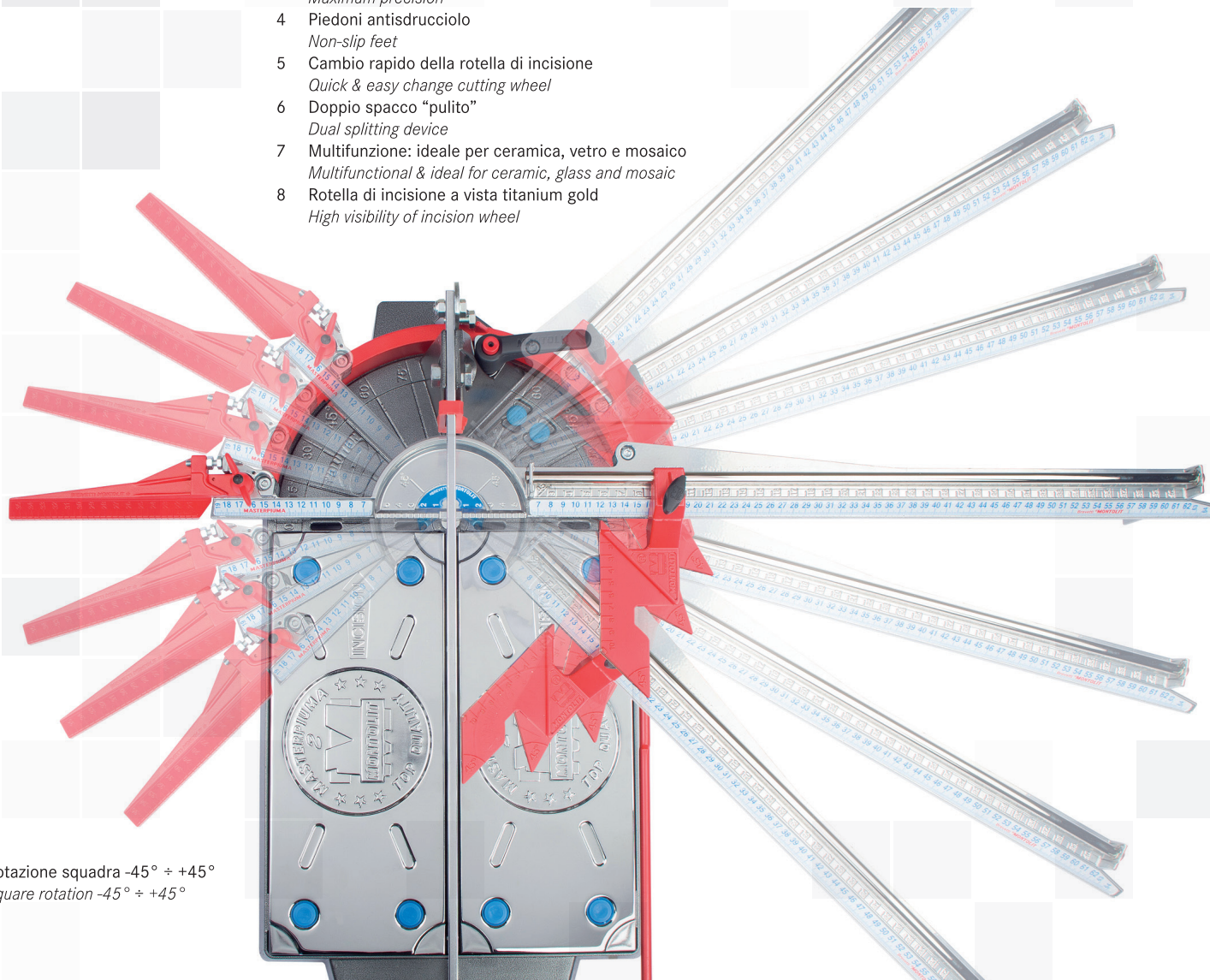

Rotazione squadra $-45^\circ \div +45^\circ$
Square rotation $-45^\circ \div +45^\circ$

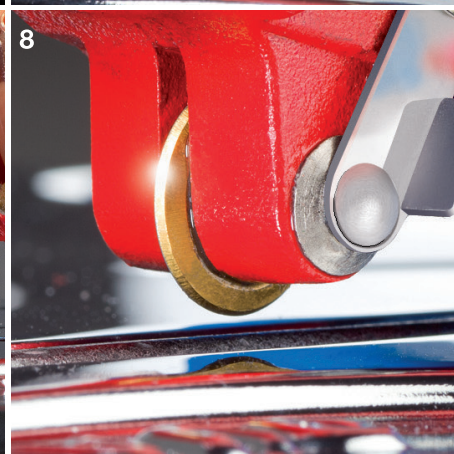
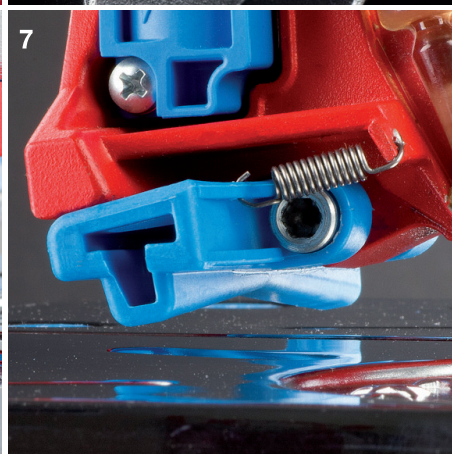
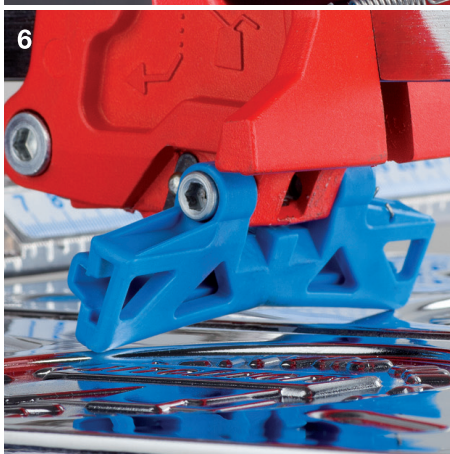
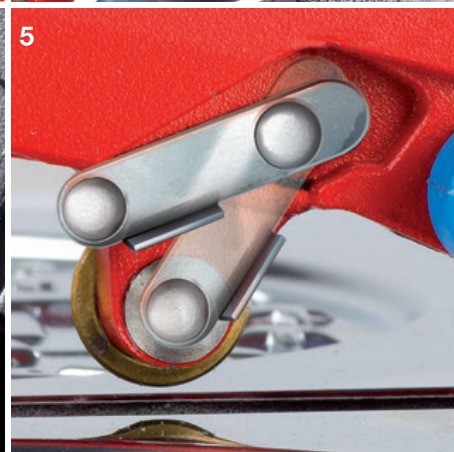

MASTERPIUMA 3 LA COMPATTA

All in One System

- 9 Squadretta di riferimento ribaltabile
Measurement square - flips out of way if not required
- 10 Piani in acciaio molleggiati
Sprung metal support tables
- 11 Box per rotelle
Box for spare incision wheel
- 12 Doppia scala graduata a "lente"
Dual millimeter scale - "lens effect"
- 13 Telaio a scatola rinforzato
Reinforced frame
- 14 Lubrificazione integrata
Integrated lubrication point
- 15 Incisione assistita da 0 a 22 mm
Incision assistance from 0 to 22 mm
- 16 Braccio estensibile per grandi formati
Extension arm for supporting big tiles

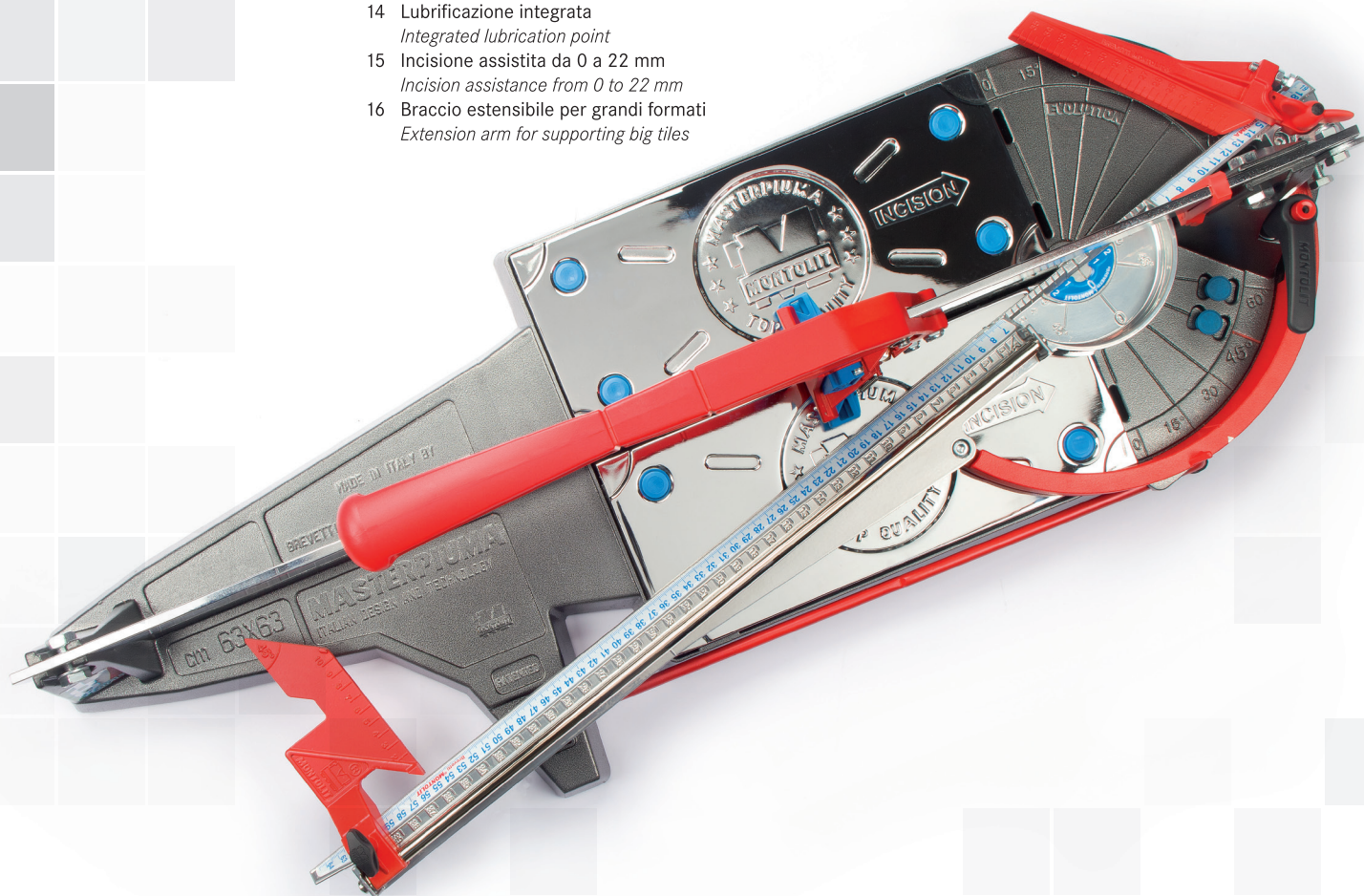

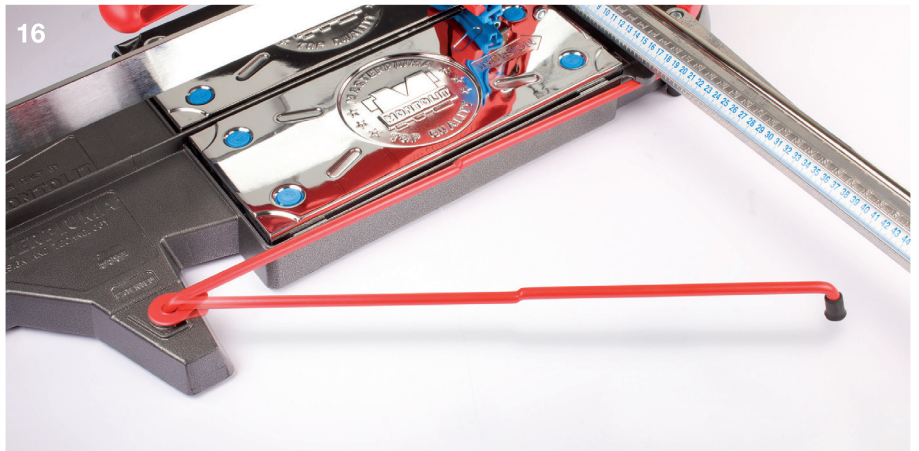
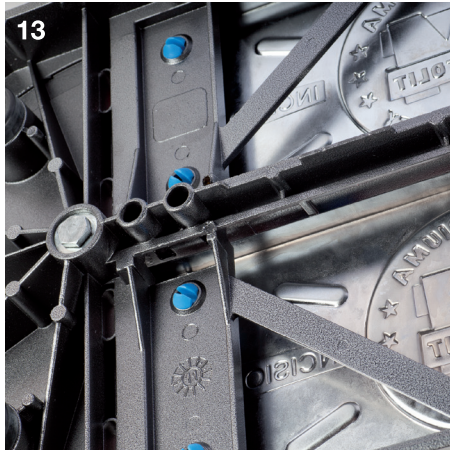
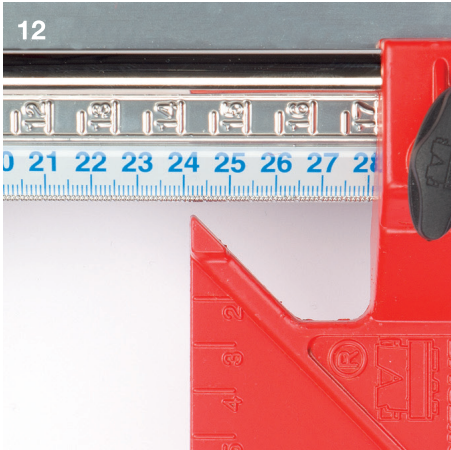
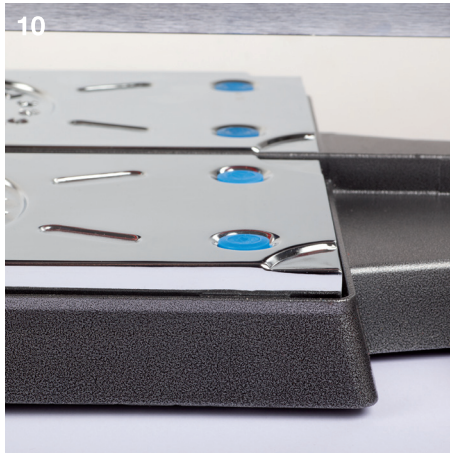
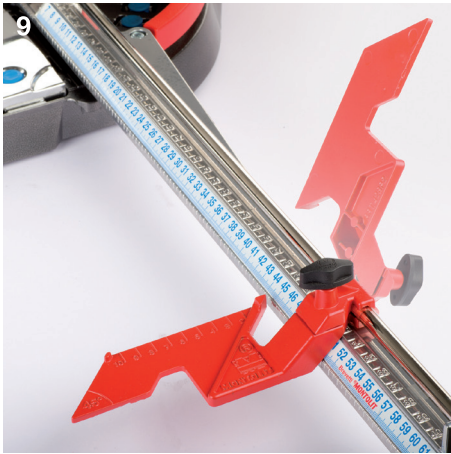

MASTERPIUMA 3 ACCESSORI

Accessories

17 - BASEBOARD ART. 64

Riferimento aggiuntivo per grandi formati ideale per il taglio di listelli e di battiscopa.

Bracket precision for cutting strip tiles and skirting boards.

18 - PIEDONE ART. 449P

Sistema di spacco supplementare per piastrelle di grandi dimensioni (fino a 155 cm) e gres porcellanato spessorato (max 2 cm).

Additional splitting system for extra large tiles size (up to 155 cm) and porcelain tile thickness (max 2 cm).

19 - MOSAKIT ART. 58

Tappetino di gomma vulcanizzata che viene posizionato sulla taglia piastrelle manuale e permette di incidere e dividere mosaici montati su carta o retina senza danneggiare il mosaico stesso.

Vulcanized rubber pad that is placed on manual tilecutters and allows to cut and divide mosaics on paper or retina without damaging the mosaic itself.



17

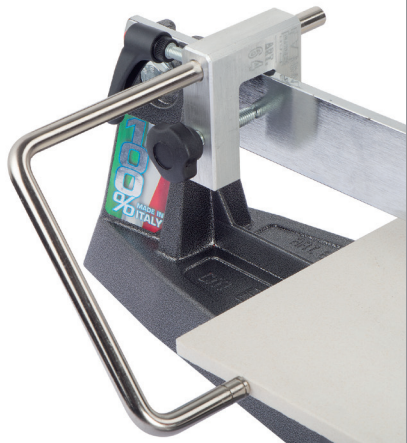

18







19



MASTERPIUMA 3 DATI TECNICI

Technical data

ART.	 cm (inch)	 cm (inch)	 cm (inch)	 Kg
44P3	44 (17")	31 x 31 (12"x12")	0 ÷ 2,2 (0 ÷ 7/8)	7,7
52P3	52 (20")	37 x 37 (14"x14")	0 ÷ 2,2 (0 ÷ 7/8)	8,2
63P3	63 (24,5")	44 x 44 (17"x17")	0 ÷ 2,2 (0 ÷ 7/8)	9,5
75P3	75 (29")	53 x 53 (21"x21")	0 ÷ 2,2 (0 ÷ 7/8)	11,8
93P3	93 (36")	66 x 66 (26"x26")	0 ÷ 2,2 (0 ÷ 7/8)	13,0
125P3	125 (49")	88 x 88 (34,5"x34,5")	0 ÷ 2,2 (0 ÷ 7/8)	24,0
155P3	155 (61")	109 x 109 (43"x43")	0 ÷ 2,2 (0 ÷ 7/8)	33,0

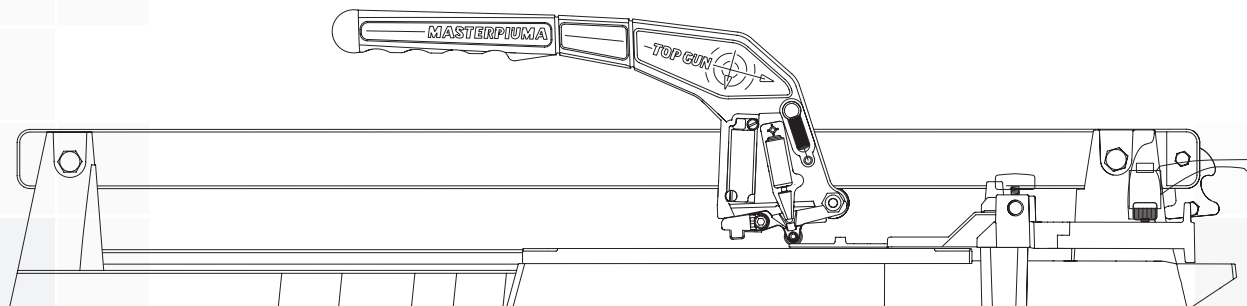

FR

1 Incision ergonomique par poussée. **2** Amortisseur. **3** Maximum de précision. **4** Pieds antidérapants. **5** Changement rapide de la roulette d'incision. **6** Double fissuration « propre ». **7** Multifonction idéal pour céramique, verre et mosaïque. **8** Roulette d'incision à vue titanium gold. **9** Équerre de référence basculante. **10** Plans d'acier amortis. **11** Box pour roulettes. **12** Double échelle graduée à loupe. **13** Cadre à boîte renforcé. **14** Lubrification intégrée. **15** Incision assistée de 0 à 22 mm. **16** Bras extensible pour grandes tailles. **17** Référence supplémentaire pour les grandes tailles idéal pour couper bandes et plinthes. **18** Système de fissuration supplémentaire pour carreaux de grande taille (jusqu'à 155 cm) et les carreaux de porcelaine calés (max 2 cm). **19** Tapis de caoutchouc vulcanisé qui est placé sur l'appareil coupe carreaux manuel et permet de graver et partager les mosaïques montés sur papier ou rétine sans endommager la mosaïque elle-même.

PT

1 Incisão ergonómica de impulso. **2** Amortizador. **3** Máxima precisão. **4** Pedais anti-derrapantes. **5** Mudança rápida da roda de incisão. **6** Separação dupla "limpa". **7** Multi-função: ideal para cerâmica, vidro e mosaico. **8** Roda de incisão de vista titanium gold. **9** Alavanca de referência basculante. **10** Planos em aço com mola. **11** Caixa para rodas. **12** Escala dupla graduada a "lente". **13** Estrutura de caixa reforçada. **14** Lubrificação integrada. **15** Incisão assistida de 0 a 22 mm. **16** Braço extensível para grandes formatos. **17** Referência adicional para grandes formatos ideal para o corte de tacos e rodapés. **18** Sistema separador suplementar para azulejos de grandes dimensões (até 155 cm) e grés porcelanato em relevo (máx. 2 Cm). **19** Tapete de borracha vulcanizada que é posicionado no cortador de azulejos manual e permite cortar e dividir mosaicos montados em cartão ou rede sem danificar o mosaico.

RU

1 Эргономичная нажимная рукоятка для выполнения надреза. **2** Амортизатор. **3** Максимальная точность. **4** Нескользящие ножки. **5** Быстрая замена роликового реза. **6** Двойной механизм слома для "чистого" разделения плитки. **7** Многофункциональный: идеален для керамики, стекла и мозаики. **8** Роликовый резец titanium gold с прямым видением линий надреза. **9** Поворотный угольник. **10** Подпружиненные стальные опорные пластины. **11** Бокс для хранения резов. **12** Двойная измерительная шкала. **13** Усиленная коробчатая конструкция рамы. **14** Встроенная система смазки. **15** Регулировка надреза от 0 а 22 мм. **16** Выдвижная опора для больших форматов **17** Дополнительная линейка для больших размеров, идеальная для резки бордюров и плитусов. **18** Дополнительная разделительная система для плиток больших размеров (до 155 см) и усиленного керамогранита (макс. 2 См). **19** Коврик из вулканизированной резины, который размещается на ручном плиткорезе и позволяет резать и разделять мозаики, закрепленные на бумаге или на сетке, не повреждая самой мозаики.

DE

1 Ergonomisch geformter Griff beim Stossen ritz und bricht man gleichzeitig. **2** Der Anschlag ist zusätzlich gedämpft **3** Höchste Genauigkeit. **4** Rutschsichere Kunststofffüsse, auswechselbar. **5** Rasches auswechseln des Rädchens möglich. **6** Der Griff (Hebel) verfügt über zwei Trennfunktionen. **7** Multifunktionell geeignet für Feinsteinzeug - Mosaik - Glas. **8** Beim Ritzen sieht man auf das Tytan (Tin) beschichtete Hartmetallrädchen. **9** Mess-Anschlag kann ohne Verstellen umgeklappt werden. **10** Gefederte Auflage aus Stahlplatten. **11** Ersatz-Rädchen sind gut versorgt und immer dabei. **12** Die doppelten Messkalen am Anschlagwinkel sind sehr gut lesbar da optisch vergrößert. **13** Kastenrahmen-System aus Alu hohe Festigkeit bei geringem Gewicht. **14** Integrierte Schmierung. **15** Ritzunterstützung bis 22 mm. **16** Zusätzlich ausfahrbarer Arm für grosses Format. **17** Zusätzlicher Bezugspunkt für große Formate, ideal zum Zuschneiden von Sockelleisten. **18** Zusätzliches Trennsystem für große Fliesen (bis 155 cm) und verstärktem Feinsteinzeug (max. 2 cm). **19** Vulkanisierte Gummimatte, die auf dem manuellen Fliesenschneider positioniert wird, sehr geeignet zum schneiden und trennen von Glasmosaik auf Papier oder Netz.

NO

1 Ergonomisk trykk snitt. **2** Støtdemper. **3** Maksimal presisjon. **4** Føtter med antiskli belegg. **5** Hurtig bytte av skjærehjul. **6** Dobbelt åpning "rent". **7** Multifunksjonell alt-i-ett: ideell for keramikk, glass og mosaikk. **8** Skjærehjul av typen titanium gull. **9** Oppfellbar lengde måler referanse. **10** Stålplate med fjæroppheng. **11** Boks for hjul. **12** Dobbelt skala med "linse". **13** Forsterket boks ramme. **14** Integriert smøring. **15** Støtte av snitt fra 0 til 22 mm. **16** Uttrekkelig arm for store dimensjoner. **17** Estra informasjon for store dimensjoner egnet for å kutte lister og gulvlister. **18** System med ekstra bredde for store fliser (opptil 155 cm) og glaseret porselen (gres) med tykkelse opptil maksimum 2 cm. **19** Vulkanisert gummimatte som er plassert på den manuelle fliskutteren og muliggjør kutt av papir- eller nett-montert mosaikk uten å skade mosaikken.

PL

1 Ergonomiczne cięcie dociskowe. **2** Amortyzator. **3** Maksymalna precyzja. **4** Nóżki antypoślizgowe. **5** Szybka zmiana ostrza tnącego. **6** "Czysty" system podwójnego nacisku. **7** Urządzenie wielofunkcyjne: idealne do ceramiki, szkła i mozaiki. **8** Widoczne ostrze tnące titanium gold. **9** Ruchoma kątomierz odniesienia. **10** Stalowe płaszczyny sprężynowe. **11** Schowek na ostrza. **12** Podwójna podziałka "soczewkowa". **13** Wzmocniona rama skrzyniowa. **14** Wbudowane smarowanie. **15** Cięcie wspomagane od 0 do 22 mm. **16** Wsuwane ramię do dużych formatów. **17** Dodatkowy odnośnik do dużych formatów, idealny do cięcia listew i listew przypodłogowych. **18** Dodatkowy łamacz do płytek o dużych wymiarach (do 155 cm) i porcelanowego gresu (max 2 cm). **19** Dywanik z gumy wulkanizowanej, który jest umieszczony na ręcznej maszynie do cięcia płytek i umożliwi nacięcie i rozdzielanie mozaik ułożonych na papierze lub siatce, nie powodując ich uszkodzenia.

NL

1 Ergonomische snede door middel van drukken. **2** Demper. **3** Maximale precisie. **4** Antislippoten. **5** Snelle wisseling van snijwieltes. **6** "Schoon" tweepunts breekmechanisme. **7** Multifunctioneel: ideaal voor keramiek, glas en mozaïek. **8** Zichtbaar snijwielte titanium gold. **9** Kantelbare winkelhaak. **10** Geveerde stalen vlakken. **11** Doos voor wieltes. **12** Dubbele schaal met "lens". **13** Frame met versterkte doos. **14** Geïntegreerde smering. **15** Ondersteunde snede van 0 tot 22 mm. **16** Uitschuifarm voor grote formaten. **17** Extra referentie voor grote formaten, ideaal voor het zagen van lijsten en plinten. **18** Extra splitsysteem voor grote tegels (maximaal 155 cm) en dik porseleingres (max. 2 Cm). **19** Gevulniseerd rubberen matje, wordt aangebracht op de handmatige tegelsnijder voor het insnijden en splijten van mozaïek op papier of vlak zonder het mozaïek te beschadigen.

CZ

1 Ergonomická rukojeť na řezání tlakem. **2** Tlumič **3** Maximální přesnost. **4** Neklouzavé nožky. **5** rychlá výměna řezacího kolečka. **6** Dvojitý čistý řez. **7** Multifunkční: ideální pro keramiku, sklo a mozaiku. **8** viditelné řezací kolečko titanium gold. **9** Sklopný vytýčovací příložník. **10** Odpružené ocelové stolky **11** Box na kolečka. **12** Dvojitá dělená stupnice se zvětšovací sklem. **13** Uzavřený zesílený rám. **14** Vestavěné mazání. **15** Asistované řezání od 0 do 22 mm. **16** prodlužovací rameno pro velké formáty. **17** Přídavný vytýčovací doraz pro velké formáty, ideální pro řezání listů a soklů. **18** Přídavný lamač pro velkorozměrové dlaždice (až do 155 cm) a silnostěnnou glazovanou dlažbu (max 2 cm). **19** Podložka z vulkanizovaného kaučuku, která se vkládá do ručních řezaček a umožňuje řezání a dělení mozaiky na podkladu ze síťoviny nebo papíru, bez poškození mozaiky.





Brevetti Montolit SpA

Sede operativa | Company Headquarters:
Via Varese 4/A - 21050 Cantello (VA) Italy

Sede legale | Legal head office:
Via Turconi, 25 - 21050 Cantello (VA) Italy

Tel. ++39 0332 419 211

Fax ++39 0332 418 444

www.montolit.com

info@montolit.com